

# Aegis Padlock DT



## User's Manual



THE LEADER IN PERSONAL STORAGE

# Table of Contents

<b>About the Aegis Padlock Desktop Drive</b>	<b>4</b>
Package contents	4
<b>Aegis Padlock DT Button Panel</b>	<b>5</b>
<b>LED states and their meaning</b>	<b>6</b>
<b>Aegis Padlock DT - Getting Started</b>	<b>7</b>
Before you begin	7
Connecting the Aegis Padlock DT	7
How do I use the Aegis Padlock DT the first time?	8
What if I forget the User PIN?	8
<b>Using the Aegis Padlock DT</b>	<b>9</b>
Entering the Standby Mode	9
Entering the User Mode	9
Exiting the User Mode	9
Entering the Admin Mode	10
Exiting the Admin Mode	10
<b>PIN Management</b>	<b>11</b>
Changing the Admin PIN	11
Adding a new User PIN	12
Deleting the User PINs	12
Changing the User PIN	12
<b>Setting the Unattended Auto Lock Feature</b>	<b>13</b>
<b>Aegis Padlock DT Brute Force Protection</b>	<b>14</b>
What is Brute Force Attack?	14
How does the Aegis Padlock DT protect against brute force attack?	14
<b>Setting a Self Destruct PIN</b>	<b>15</b>

<b>Completely resetting the Aegis Padlock DT</b>	<b>16</b>
Initializing and formatting the Aegis Padlock DT after a complete reset	16
<b>Hibernating or Logging off from the OS</b>	<b>18</b>
<b>Aegis Padlock DT Setup for Mac OS</b>	<b>18</b>
<b>Diagnostic Mode</b>	<b>19</b>
<b>Troubleshooting</b>	<b>20</b>
<b>Technical Support</b>	<b>22</b>
Warranty and RMA information	22

Copyright © Apricorn, Inc 2014. All rights reserved.

Windows is a registered trademark of Microsoft Corporation.  
All other trademarks and copyrights referred to are the property of their respective owners.

Distribution of modified versions of this document is prohibited without the explicit permission of the copyright holder.

Distribution of the work or derivative work in any standard (paper) book form for commercial purposes is prohibited unless prior permission is obtained from the copyright holder.

DOCUMENTATION IS PROVIDED AS IS AND ALL EXPRESS OR IMPLIED CONDITIONS, REPRESENTATIONS AND WARRANTIES, INCLUDING ANY IMPLIED WARRANTY OF MERCHANTABILITY, FITNESS FOR A PARTICULAR PURPOSE OR NON-INFRINGEMENT, ARE DISCLAIMED, EXCEPT TO THE EXTENT THAT SUCH DISCLAIMERS ARE HELD TO BE LEGALLY INVALID

**(Rev 1.3)** 9/17/2014

# About the Aegis Padlock Desktop Drive



Looking for an effortless way to secure your data? Look no further than the Aegis Padlock DT.

With an easy-to-use keypad design and software free setup, the Aegis Padlock DT enables you to access the drive with your own unique pin. Featuring 256 bit hardware encryption and a super-fast USB 3.0 connection, the Aegis Padlock DT provides seamless real-time encryption, keeping your data safe 24/7.



## Package contents

- Aegis Padlock DT
- AC Adapter
- USB 3.0 data cable (backwards compatible with USB 2.0)
- Quick Start Guide

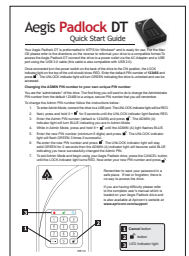

# Aegis Padlock DT Button Panel

- 1** Cancel button
- 2** UNLOCK button
- 3** LED Indicator lights

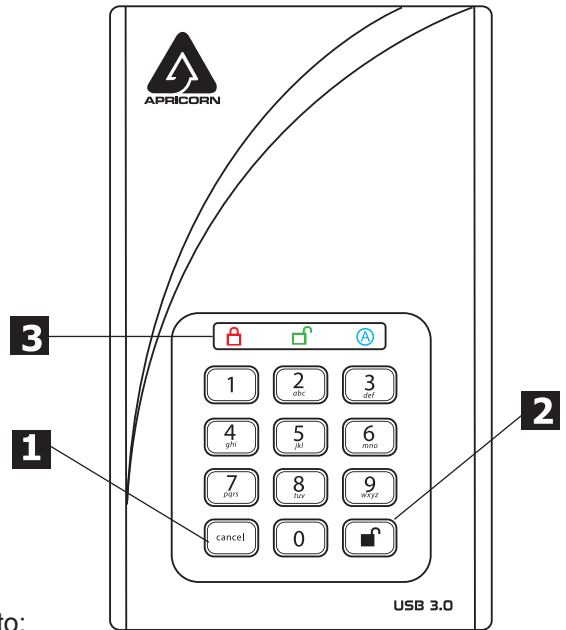



The **“Cancel”** button can be used to:

- Cancel current operation
- Return to the previous step when you knowingly entered a wrong PIN
- Exit the Admin Mode

The **UNLOCK** button can be used to access the Aegis Padlock DT and it can also be used as an OK acknowledgement in the following operations:







- Entering a PIN
- Confirming a new PIN

The indicator light displays the following colors to indicate the various modes of operation:

- RED: Standby Mode 
- BLUE: Admin Mode 
- GREEN: User Mode 

The LED indicator light has other display methods to indicate different status of the Aegis Padlock DT. Details are provided later in this chapter.

# LED states and their meaning

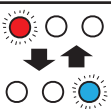
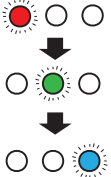
	No LEDs	Drive locked and asleep
	Blinking <b>RED</b>	Error / incorrect key entry. Also used for Mode Not Available / User PIN Change
	Solid <b>RED</b>	Stand-by state, waiting for key entry
	Blinking <b>GREEN</b>	Key entry accepted
	Solid <b>BLUE</b> / Blinking <b>GREEN</b>	Waiting to enter new User / Admin PIN
	Solid <b>BLUE</b>	In Admin Mode
	Solid <b>GREEN</b>	Drive unlocked
	Alternating <b>RED</b> / <b>BLUE</b>	Indicates a mode has been entered that can result in the deletion of a User or the Data on the drive (depending on the mode chosen). Also used when setting Auto-lock feature
	One second <b>RED</b> followed by one second <b>GREEN</b> followed by one second <b>BLUE</b>	Self-test mode to ensure all components are ready and working properly

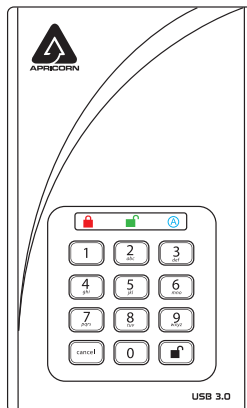

# Aegis Padlock DT - Getting Started

## Before you begin



Attention: Use only the included cables with your Aegis Padlock DT. You might damage the drive if you use a cable not included with the Aegis Padlock DT.

## Connecting the Aegis Padlock DT

1. Ensure that the power switch on the back of the Aegis Padlock DT is in the OFF position.
2. Connect the Aegis Padlock DT to a power outlet using the included AC Adapter.
3. Attach the USB cable to the Aegis Padlock DT drive and to an available USB port on your computer.
4. Turn the power switch on the back of the Aegis Padlock DT to the ON position.
5. The unit will do a self-test to verify all security components are working properly. The LEDs will go through 3 test stages **RED**, **GREEN**, and **BLUE**. This will be followed by three **GREEN** flashes on a successful test. Any test failure will leave the unit in an interoperable state with the **RED** LED flashing.
6. Once the self test is successfully completed, if the drive has never been used the LED will display Solid **BLUE** and Solid **GREEN** to indicate the Padlock is waiting for an Admin PIN to be set. If the drive has been used before and has an Admin PIN, the drive will be in Standby mode and the LED will be on solid **RED**.

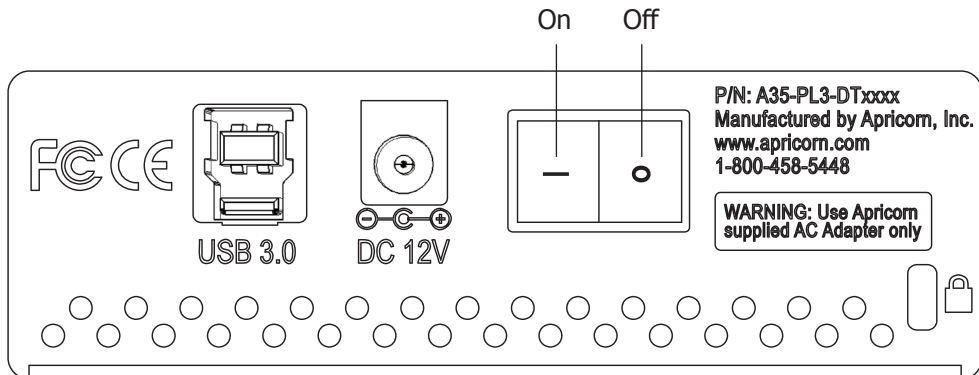

# How do I use the Aegis Padlock DT the first time?

Before the Padlock DT can be used, the Admin PIN MUST be set. The LED will display Solid **BLUE** and Solid **GREEN** to indicate the Padlock is waiting for a PIN to be set.

## To Set-up the Admin PIN:

1. Press **UNLOCK + 9**. The LED will change to Solid **BLUE** and Blinking **GREEN**.
2. Enter the new Admin PIN and press **UNLOCK** key. If accepted the **GREEN** LED will flash for three short blinks, then return to Solid **BLUE** and Blinking **GREEN**.
3. Re-enter the Admin PIN and press the **UNLOCK** key. If accepted the **GREEN** LED will be Solid for three seconds.
4. LED will then turn **BLUE** and remain in Admin mode for 30 seconds or if the **Cancel** key is pressed, will return the drive to a standby state.
5. The Admin PIN is now set and will allow access to the drive or the Admin features.
6. To **UNLOCK** the drive, exit Admin by pressing the **Cancel** button. Then enter the new PIN and press **UNLOCK**.

\*Note: PINs must be a minimum length of 7 maximum 16 digits.  
Cannot contain all consecutive numbers (2345678 or 9876543)  
Cannot contain all same number (1111111)

## What if I forget the User PIN?

Use your Admin PIN to enter Admin Mode, and then create another User PIN in Admin Mode.



**NOTE:** If you forget or lose your ADMIN PIN there is no way to access the drive. Even an Apricorn employee will be unable to help you access your data. In the event that this happens, the only way to use the drive is to do a complete reset, which will reset the encryption key making all data on the drive unrecoverable.

See the Chapter “Completely Resetting your Aegis Padlock DT” for instructions.



# Using the Aegis Padlock DT

## *Entering and exiting the Standby Mode, Admin Mode, and User Mode*

---

### Entering the Standby Mode

The Standby Mode is the default mode of the Aegis Padlock DT and is the gateway to other operations.

To enter the Standby Mode, attach the USB cable to an available USB port on your computer and turn the Aegis Padlock DT ON. The drive automatically goes into its self test verification (see Connecting the Aegis Padlock DT) before going into Standby Mode turning the LED **RED**. In this mode, the Aegis Padlock DT is locked. It cannot be recognized by **My Computer** and it does not provide either the regular functions or the encryption function. However, it enables you to enter and switch between the Admin Mode and the User Mode.



Attention: To switch between the Admin Mode and the User Mode, you are required to switch to the Standby Mode first, and then you can enter the mode of your choice.

### Entering the User Mode

To enter the User Mode, do the following:

1. From the Standby mode enter the User PIN or the Admin PIN and press the **UNLOCK** button. The LED turns **GREEN** indicating that the drive is in the User Mode. If the LED flashes **RED**, you need to re-enter the correct PIN.

### Exiting the User Mode

To exit the User Mode, press the **“Cancel”** button on the Aegis Padlock DT keypad. If there is no activity for five seconds the drive will lock and go into Standby mode.

Alternately, you can turn your Aegis Padlock DT OFF at the power switch on the back of the unit. Once you turn the Aegis Padlock DT ON again, the Padlock DT will go through its self test verification process before turning the LED **RED**, indicating that you are in the Standby Mode.

# Entering the Admin Mode

*Note: The Aegis Padlock DT cannot be recognized by the operating system in the Admin Mode.*

To enter the Admin Mode, do the following:

1. From Standby mode press and hold **UNLOCK + 0** for five seconds until the LED flashes **RED**. This indicates that you can enter the Admin PIN.
2. Enter the Admin PIN and press **UNLOCK**. The drive is in Admin Mode when the LED has changed to **BLUE**.



Note: If the LED flashes **RED** for a few seconds, indicating the Aegis Padlock DT has returned to the Standby Mode, go back to Step 2. This is due to one of the following conditions:

- You entered an incorrect Admin PIN.
- No activity was detected within ten seconds in the Admin Mode.

# Exiting the Admin Mode

To exit the Admin Mode, press the “**Cancel**” button on the Aegis Padlock DT keypad. If there is no activity for five seconds the drive will lock and go into Standby mode.

Alternately, you can turn your Aegis Padlock DT OFF at the power switch on the back of the unit. Once you turn the Aegis Padlock DT ON again, the Padlock DT will go through its self test verification process before turning the LED **RED**, indicating that you are in the Standby Mode.

# PIN Management

This section provides information about managing your PIN in the Admin Mode and User Mode.

## Changing the Admin PIN

You can change the Admin PIN by doing the following:

1. Enter Admin Mode (**UNLOCK + 0** for five seconds. Enter Admin PIN and press **UNLOCK**).
2. Press and hold **UNLOCK + 9** until the LED turns to Solid **BLUE** and Blinking **GREEN**.
3. Enter the new PIN and press **UNLOCK** (The PIN must be a minimum of 7 digits and a maximum of 16 digits). The LED flashes **GREEN** three times, then returns to Solid **BLUE** and Blinking **GREEN**.
4. Re-enter the new Admin PIN and press **UNLOCK**. The LED stays solid **GREEN** for two seconds and then solid **BLUE** indicating that the Admin PIN has been changed successfully.



Note: If the LED flashes **RED** three times, this indicates that the PIN is less than 7 digits or more than 16 digits. Enter a PIN that contains 7 – 16 digits after the LED flashes **BLUE** intermittently.

1. If the LED flashes **RED** intermittently and then **BLUE** intermittently, go back to step 3. This is due to one of the following conditions:
  - You waited longer than ten seconds before entering a PIN.
  - The new PIN was entered incorrectly.
2. If no activity is detected within two minutes in the Admin Mode, the Aegis Padlock DT will return to the Standby Mode.

## Adding a new User PIN

1. Enter the Admin Mode (**UNLOCK + 0** for five seconds. Enter Admin PIN and press **UNLOCK**).
2. Press and hold **UNLOCK + 1** until the LED turns to Solid **BLUE** and Blinking **GREEN**.
3. Enter a User PIN and press **UNLOCK** (a minimum of 7 digits and a maximum of 16 digits). The LED flashes **GREEN** three times, then returns to Solid **BLUE** and Blinking **GREEN**.
4. Re-enter the new User PIN and press **UNLOCK**. If the LED stays solid **GREEN** for two seconds and then solid **BLUE**, the User PIN was successfully added.

## Deleting the User PINs

You can delete all User PINs by doing the following:

1. Enter the Admin Mode (**UNLOCK + 0** for five seconds. Enter Admin PIN and press **UNLOCK**).
2. Press and hold **7 + 8 + UNLOCK** for five seconds until the LED flashes **GREEN** three times and then changes to **BLUE / RED** alternating.
3. Press and hold **7 + 8 + UNLOCK** a second time for five seconds until the LED goes on solid **GREEN** for two seconds and then back to solid **BLUE**, this indicates that the User PINs were deleted successfully.

## Changing the User PIN

1. Unlock the drive by inputting your User PIN and pressing the **UNLOCK** button.
2. Press and hold **UNLOCK + 1** until the LED flashes **RED**.
3. Enter your current PIN and press **UNLOCK**.  
The LED will be Solid **BLUE** and Solid **GREEN**.
4. Enter the new PIN and press **UNLOCK** (The PIN must be a minimum of 7 digits and a maximum of 16 digits). The LED will flash **GREEN** three times, then returns to Solid **BLUE** and Blinking **GREEN**.
5. Re-enter the new User PIN and press **UNLOCK**. The LED stays solid **GREEN** indicating that the User PIN has been changed successfully.

# Setting the Unattended Auto Lock Feature

To protect against unauthorized access if the drive is unlocked and unattended, the Aegis Padlock DT can be set to automatically lock after a pre-set amount of time.

In its default state, the Aegis Padlock Unattended Auto Lock feature is turned off.

The Unattended Auto Lock can be set to activate after 5, 10 or 20 minutes.

To set the Unattended Auto Lock please use the following steps:

1. Enter the Admin mode by pressing and holding **UNLOCK + 0** for five seconds until the LED flashes **RED**. This indicates that you can enter the Admin PIN.
2. Enter the Admin PIN and press **UNLOCK**. The drive is in Admin Mode when the LED has changed to solid **BLUE**.
3. Once in Admin mode, press **UNLOCK + 6**. The LED should start flashing **RED** and **BLUE** intermittently.
4. Press one of the numbers below that corresponds to amount of time you would like the drive to lock after no activity:

## Auto Lock Timeout Table:

1 = 5 min

2 = 10 min

3 = 20 min

0 = OFF

The default is 0 (OFF)

5. After you have input the number, the LED should flash **GREEN** 3 times to indicate that you have successfully set the Unattended Auto Lock feature.

# Aegis Padlock DT Brute Force Protection

## What is Brute Force Attack?

A brute force attack is a method of defeating a cryptographic scheme by systematically trying a large number of possibilities; for example, a large number of the possible keys in a key space in order to decrypt a message. In most schemes, the theoretical possibility of a brute force attack is recognized, but it is set up in such a way that it would be computationally infeasible to carry out. Accordingly, one definition of “breaking” a cryptographic scheme is to find a method faster than a brute force attack.

## How does the Aegis Padlock DT protect against brute force attack?

1. With the drive locked and in the standby state the LED will be solid **RED**.
2. After five tries entering the incorrect user or admin PIN attempts, the keypad will not respond and LED will turn off. The drive will need to be unplugged from the USB port and re-plugged.
3. If the user, unsuccessfully tries to unlock the drive on the tenth try the keypad will lock and the LED will begin blinking **RED** quickly. Even after unplugging and re-plugging in the unit, the drive will remain locked and the LED will continue to blink rapidly.

**Here are the steps to allow the user to unlock the keypad for 10 more attempts to unlock this drive.**

4. Push and hold the **5** key and switch the Power button to **ON** on the back of the drive
5. The LED will be blinking alternating **RED** and **GREEN** rapidly
6. Enter the code “LastTry” (PIN: 5278879) and press **UNLOCK**.
7. The keypad will unlock and will be in the standby state with the LED solid **RED**, this will allow only 10 more attempts
8. After a total of 20 Attempts the drive will remain locked with the LED flashing **RED** quickly. You must now go through the reset process and reformat the drive to be able to use the drive again.

# Setting a Self Destruct PIN

The Aegis Padlock DT has the ability to set a PIN that will reset the encryption key if needed. By resetting the encryption key all data on the drive will be lost and cannot be recovered.



After initiating the Self Destruct sequence, the PIN used to initiate the self destruct sequence will become the default Admin PIN. The drive will need to be initialized and reformatted.

To set a Self Destruct PIN please use the following steps:

1. Enter the Admin mode by pressing and holding **UNLOCK + 0** for five seconds until the LED flashes **RED**. This indicates that you can enter the Admin PIN.
2. Enter the Admin PIN and press **UNLOCK**. The drive is in Admin Mode when the LED has changed to **BLUE**.
3. Once in Admin mode, press **UNLOCK + 3**. LED will be alternating **BLUE / RED**.
4. Input in the PIN that you would like to use as the Self Destruct PIN and press **UNLOCK**.
5. If the Self Destruct PIN is accepted the LED flashes **GREEN**.
6. Immediately re-enter the new PIN and press **UNLOCK**. If the LED stays solid **GREEN** for two seconds and then goes to solid **BLUE**, the Self Destruct PIN was added successfully.
7. To delete the Self Destruct PIN, you will need to delete all of the User PINs. Disconnect and re-connect the drive, then refer to the instructions Deleting User PINs.



**Note:** The PIN must be a minimum of 7 digits in the length (16 max) and cannot match any Admin or User codes already used by the drive.

In the future, a User or Admin code can not be set to the same number as used by the Self Destruct PIN.

# Completely resetting the Aegis Padlock DT

If you forget all the User PINs or Admin PINs, you can perform a complete reset to remove all the User PINs, and the Admin PIN.



Attention: Completely resetting the Aegis Padlock DT will perform a crypto-erase and reset the encryption key, in effect making all the data on the drive unrecoverable. You will need to partition and format the Aegis Padlock DT with disk management applications.

To perform a complete reset of the drive, do the following:

1. Connect the Aegis Padlock DT to an available USB port. Turn on the power switch on the back of the drive while holding the **Cancel** button. The LED will flash **RED**, **GREEN** and **BLUE** alternately.
2. Release the **Cancel** button.
3. Press and hold **Cancel + UNLOCK + 2** for ten seconds until the LED turns Solid **GREEN** for two seconds, followed by Solid **BLUE** and Solid **GREEN**. You have successfully reset the Aegis Padlock DT.

## Initializing and formatting the Aegis Padlock DT after a complete reset

A complete reset of the Aegis Padlock DT will erase all information and partition settings. You will need to initialize and format the Aegis Padlock DT.

To initialize your Aegis Padlock DT, do the following:

1. After a complete reset, attach the Aegis Padlock DT to the computer.
2. Wait five seconds for the computer to recognize the device.
3. Press **UNLOCK + 9**. The LED will change to Solid **BLUE** / Blinking **GREEN**.
4. Enter the new Admin PIN and press **UNLOCK** key. If accepted the LED will flash three short blinks of the **GREEN** LED, then return to Solid **BLUE** and Blinking **GREEN**.



5. Re-enter the Admin PIN and press the UNLOCK key. If accepted the **GREEN** LED will be Solid for two seconds.
6. LED will then turn **BLUE** and remain in Admin mode for 30 seconds or if the LOCK key is pressed, will return the drive to a standby state.
7. The Admin PIN is now set and will allow access to the drive or the Admin features.
8. To UNLOCK the drive, enter the new PIN and press UNLOCK.
9. Windows 7 and earlier: Right-click My Computer, and then click Manage from the Windows desktop.
10. Windows 8: Right click left corner of desktop and select Disk Management.
11. In the Computer Manage window, click Disk Management. In the Disk Management window, the Aegis Padlock is recognized as an unknown device that is uninitialized and unallocated.
12. Do the following to make the drive recognized as a basic drive.
13. If the Initialize and Convert Disk Wizard window opens, click Cancel, then initialize the disk manually using the following steps.
14. Do the following to make the drive recognized as a basic drive.
  - If the Initialize and Convert Disk Wizard window opens, click **Cancel**, then initialize the disk manually using the following steps.
    - a. Right-click Unknown Disk, and then select Initialize Disk.
    - b. In the Initialize Disk window, click **OK**.
15. Right-click in the blank area under the Unallocated section, and then select New Partition. The Welcome to the New Partition Wizard window opens.
16. Click Next.
17. Select Primary partition and click Next.
18. If you need only one partition, accept the default partition size and click Next.
19. Click Next.
20. Create a volume label, select Perform a quick format, and then click Next.
21. Click Finish.
22. Wait until the format process is complete. The Aegis Padlock will be recognized and it is available for use.

# Hibernating, Suspending, or Logging off from the Operating System

Be sure to save and close all the files on your Aegis Padlock DT before hibernating, suspending, or logging off from the Windows operating system.

It is recommended that you log off the Aegis Padlock DT manually before hibernating, suspending, or logging off from your system.

To log off the Aegis Padlock DT, double-click Safely Remove Hardware on the Windows desktop and remove the Aegis Padlock DT from your computer.



**Attention:** To ensure the data integrity of your Aegis Padlock DT, be sure to lock or log off your Aegis Padlock DT if you are:

- away from your computer
- using the switching user function by sharing a computer with others

## Aegis Padlock DT Setup for Mac OS

Your Aegis Padlock is preformatted in NTFS for Windows. To reformat the drive to a Mac compatible format please read the below.

Once the drive is unlocked, open Disk Utility from Applications/Utilities/Disk Utilities. To format the Aegis Padlock DT:

1. Select the Aegis Padlock from the list of drives and volumes. Each drive in the list will display its capacity, manufacturer, and product name, such as 232.9 Apricorn Padlock DT.
2. Click the 'Erase' tab.
3. Enter a name for the drive. The default name is Untitled. The drive's name will eventually appear on the desktop.
4. Select a volume format to use. The Volume Format dropdown menu lists the available drive formats that the Mac supports. The recommended format type is 'Mac OS Extended (Journaled).'
5. Click the 'Erase' button. Disk Utility will unmount the volume from the desktop, erase it, and then remount it on the desktop.

# Diagnostic Mode

The keypad has a manual diagnostic mode built in to verify proper keypad function. This mode will not allow access to any data or admin function. It can only be used to identify the firmware level and to test button recognition.

The diagnostic mode is also useful for troubleshooting key issues.

To enter the diagnostic function:

1. Turn the Power switch on the back of the drive to the **ON** position. During Power up hold 0 key until the Power-On-Self-Test (POST) completes.
2. The LED will flash **BLUE** for the major and minor revisions and **RED** LED to indicate (.). When complete, the LED will return to a solid **BLUE** LED

**(Example: Four BLUE flashes followed by one RED flash followed by one BLUE flash followed by one RED flash would indicate version 4.1.)**

3. Key presses after the revision will coincide with the number pressed using the **RED** LED.
4. Example: 1 = 1 flash, 2 = 2 flashes, 3 = 3 flashes, 0 = 10 flashes
5. Unlock = 11 flashes, Cancel = 12 flashes.
6. To Exit the Diagnostic Mode, a power re-set is required. Using the Power switch on the back of the drive, turn the drive **OFF** then **ON** to return to normal operation.

# Troubleshooting

This section contains troubleshooting information for the Aegis Padlock DT. If you encounter any of the following problems when using the Aegis Padlock DT, refer to the corresponding answers.

**Q: I enter the drive with the default PIN but am not able to change the code. Why?**

**A:** You are entering the drive using the Admin PIN. This code can only be changed from the Admin mode.

**Q: What can I do if I forget the User PIN?**

**A:** Use your Admin PIN to enter Admin Mode, and then create another User PIN in Admin Mode.

**Q: What can I do if I forget the Admin PIN?**

**A:** There is no other way to retrieve the Admin PIN except a complete reset of the Aegis Padlock DT. After a complete reset, all data will be lost and you will need to initialize, allocate and format the Aegis Padlock DT manually.

**Q: Why did the operating system not recognize the Aegis Padlock DT after I enter the User Mode and completely reset the computer?**

**A:** You need to initialize, allocate and format the Aegis Padlock DT manually. For more information, refer to **Initializing and formatting the Hard Drive after a complete reset** in this manual.

**Q: How do I use the Aegis Padlock DT without a PIN?**

**A:** As a full disk encryption product, the Aegis Padlock DT can never be used without a PIN.

**Q: What encryption algorithm is used in this product?**

**A:** The Aegis Padlock DT uses AES XTS 256-bit algorithm.

**Q: Why could I not initialize, partition or format the Aegis Padlock DT?**

**A:** Ensure that your user account has administrator privileges. Only accounts with Administrator privileges have access to Disk Management and the permissions to format and partition drives.

**Q: Why does the LED indicate an error when I try to change the PIN?**

**A:** PIN requirements for this drive are must meet a minimum security level. There are several combinations that are not allowed, such as, all repeating numbers, sequential number going up or down. The PIN must also be a minimum of 7 digits and cannot be longer than 16 digits.

**Q: What are the ECCN and HST codes used for shipping this device outside the US?**

**A:** ECCN: 5A992A and HTS code 8473.50.3000

# Technical Support

Apricorn provides the following helpful resources for you:

1. Apricorn's Website (<http://www.apricorn.com>)

This gives you the ability to check for up-to-date information

2. E-mail us at [support@apricorn.com](mailto:support@apricorn.com)

3. Or call the Technical Support Department at **1-800-458-5448**

Apricorn's Technical Support Specialists are available from 8:00 a.m. to 5:00 p.m., Pacific Standard Time Monday through Friday

## Warranty and RMA information

### **One Year Limited Warranty:**

Apricorn offers a 1-year limited warranty on the Aegis Padlock DT against defects in materials and workmanship under normal use. The warranty period is effective from the date of purchase either directly from Apricorn or an authorized reseller.

### **Disclaimer and terms of the warranties:**

THE WARRANTY BECOMES EFFECTIVE ON THE DATE OF PURCHASE AND MUST BE VERIFIED WITH YOUR SALES RECEIPT OR INVOICE DISPLAYING THE DATE OF PRODUCT PURCHASE.

APRICORN WILL, AT NO ADDITIONAL CHARGE, REPAIR OR REPLACE DEFECTIVE PARTS WITH NEW PARTS OR SERVICEABLE USED PARTS THAT ARE EQUIVALENT TO NEW IN PERFORMANCE. ALL EXCHANGED PARTS AND PRODUCTS REPLACED UNDER THIS WARRANTY WILL BECOME THE PROPERTY OF APRICORN.

THIS WARRANTY DOES NOT EXTEND TO ANY PRODUCT NOT PURCHASED DIRECTLY FROM APRICORN OR AN AUTHORIZED RESELLER OR TO ANY PRODUCT THAT HAS BEEN DAMAGED OR RENDERED DEFECTIVE: 1. AS A RESULT OF ACCIDENT, MISUSE, NEGLIGENCE, ABUSE OR FAILURE AND/OR INABILITY TO FOLLOW THE WRITTEN INSTRUCTIONS PROVIDED IN THIS INSTRUCTION GUIDE; 2. BY THE USE OF PARTS NOT MANUFACTURED OR SOLD BY APRICORN; 3. BY MODIFICATION OF THE PRODUCT; OR 4. AS A RESULT OF SERVICE, ALTERNATION OR REPAIR BY ANYONE OTHER THAN APRICORN AND SHALL BE VOID. THIS WARRANTY DOES NOT COVER NORMAL WEAR AND TEAR.

NO OTHER WARRANTY, EITHER EXPRESS OR IMPLIED, INCLUDING ANY WARRANTY OR MERCHANTABILITY AND FITNESS FOR A PARTICULAR PURPOSE, HAS BEEN OR WILL BE MADE BY OR ON BEHALF OF APRICORN OR BY OPERATION OF LAW WITH RESPECT TO THE PRODUCT OR ITS INSTALLATION, USE, OPERATION, REPLACEMENT OR REPAIR.

APRICORN SHALL NOT BE LIABLE BY VIRTUE OF THIS WARRANTY, OR OTHERWISE, FOR ANY INCIDENTAL, SPECIAL OR CONSEQUENTIAL DAMAGE INCLUDING ANY LOSS OF DATA RESULTING FROM THE USE OR OPERATION OF THE PRODUCT, WHETHER OR NOT APRICORN WAS APPRISED OF THE POSSIBILITY OF SUCH DAMAGES.



**APRICORN**

© Apricorn, Inc. 2014. All rights reserved.  
12191 Kirkham Road  
Poway, CA, U.S.A. 92064  
1-858-513-2000 [www.apricorn.com](http://www.apricorn.com)